



# Super Copa Espana Senior Barcelona 2019

Barcelona (CAT), 16 Feb 2019

## -60 kg

14 Judoka

POOL A

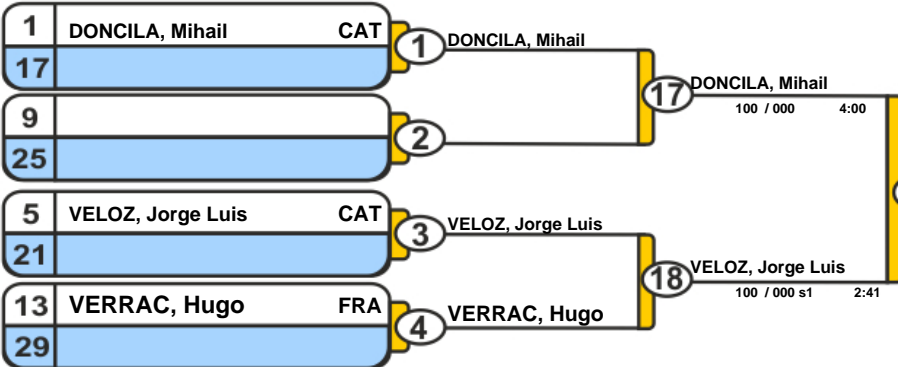

POOL B

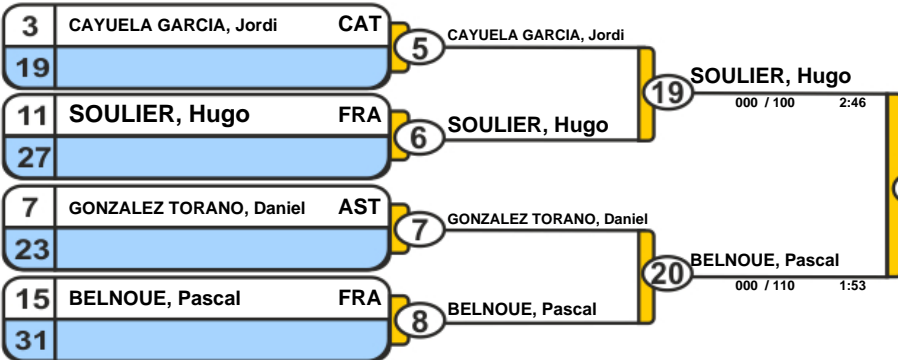

POOL C

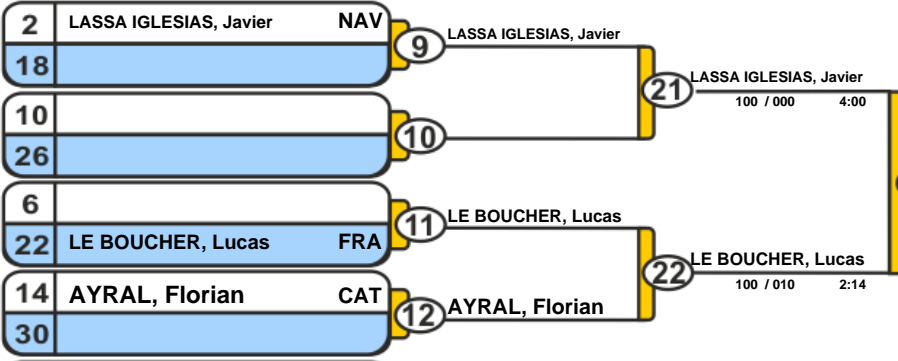

POOL D

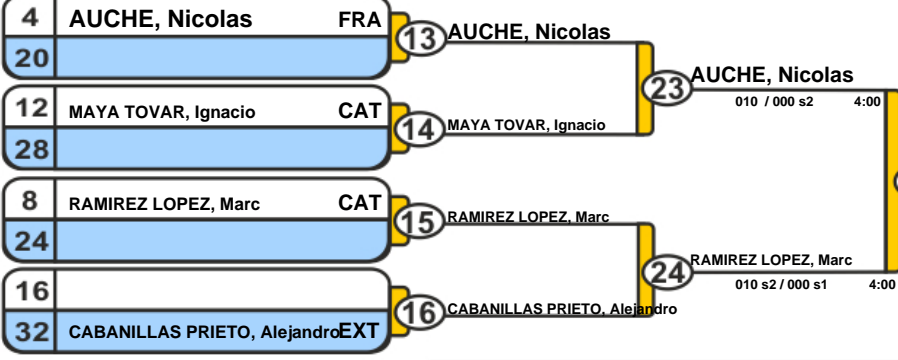

BELNOUE, Pascal  
1. 110 s1 / 010 s2 4:58 **43**

**38** AUCHE, Nicolas  
000 / 100 0:36

Results		
Résultat / Platzierungen / Resultados		
1.	BELNOUE, Pascal	FRA
2.	AUCHE, Nicolas	FRA
3.	VELOZ, Jorge Luis	CAT
3.	DONCILA, Mihail	CAT
5.	LE BOUCHER, Lucas	FRA
5.	LASSA IGLESIAS, Javier	NAV
7.	GONZALEZ TORANO, Daniel	AST
7.	MAYA TOVAR, Ignacio	CAT

### Trostrunde / Repechage / Ronda de consolación

Repechage / Trostrunde / Repechage

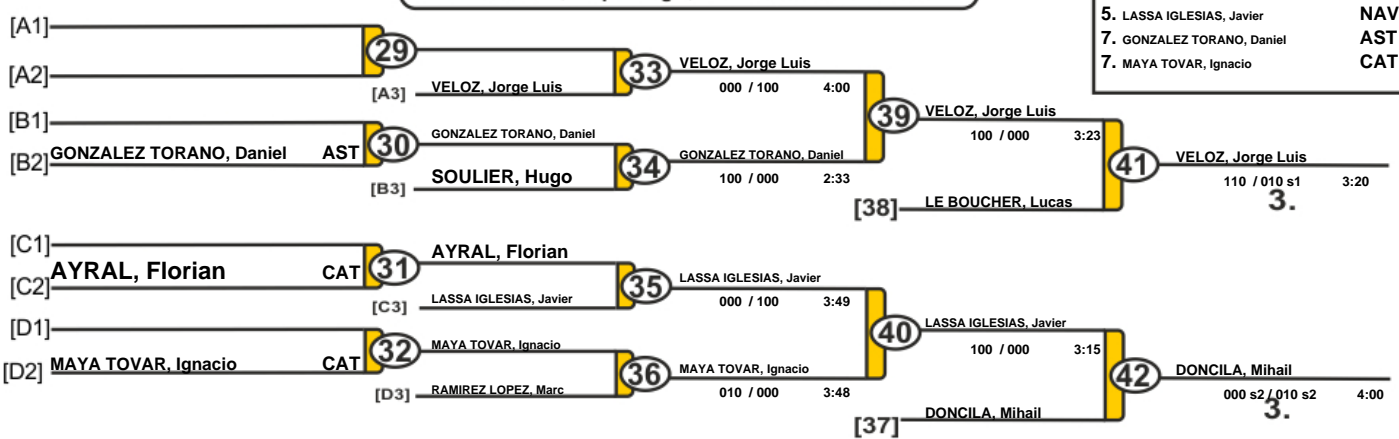



# Super Copa Espana Senior Barcelona 2019

Barcelona (CAT), 16 Feb 2019

## -66 kg

13 Judoka

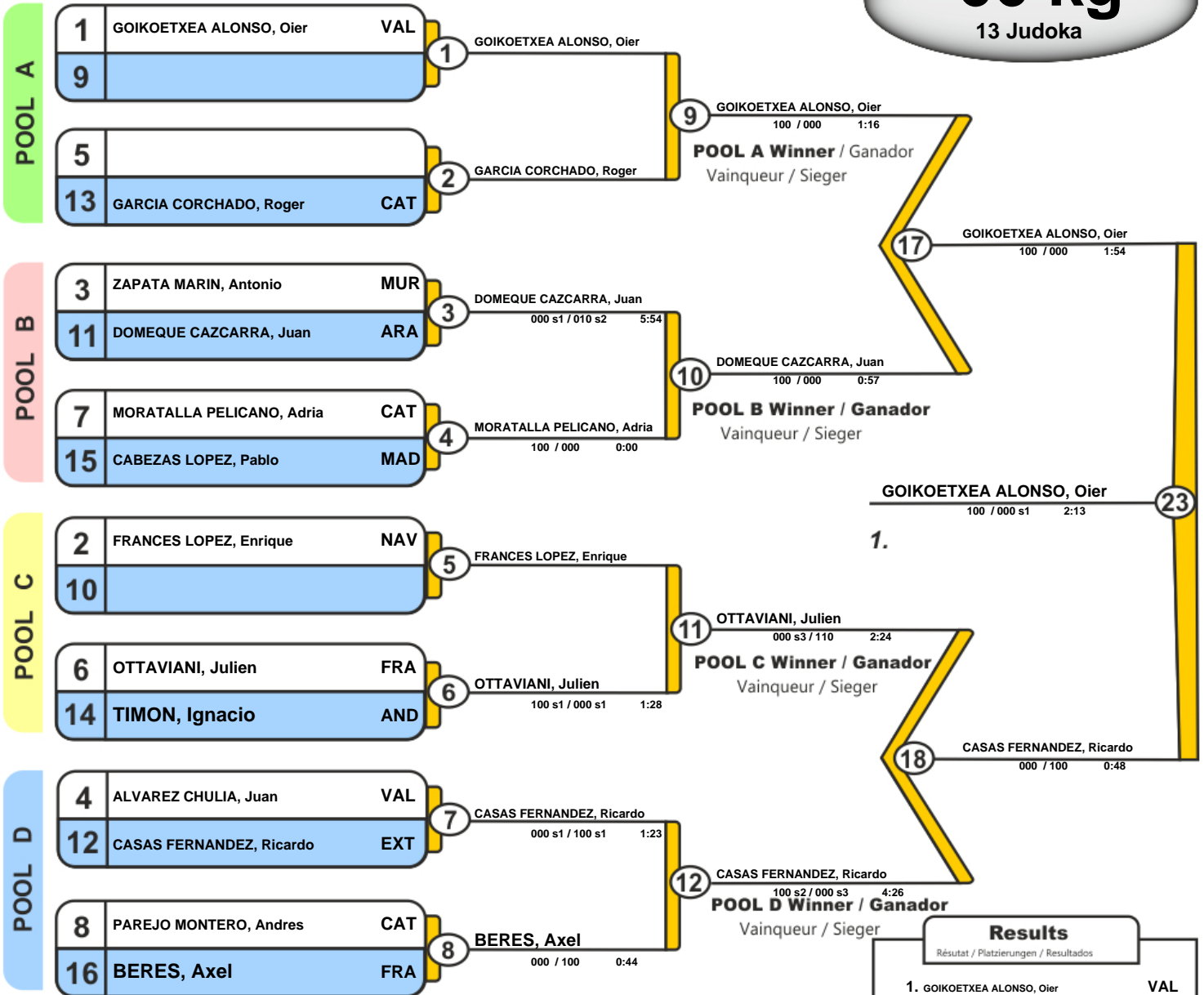

Results		
Résultat / Platzierungen / Resultados		
1.	GOIKOETXEA ALONSO, Oier	VAL
2.	CASAS FERNANDEZ, Ricardo	EXT
3.	OTTAVIANI, Julien	FRA
4.	BERES, Axel	FRA
5.	ZAPATA MARIN, Antonio	MUR
6.	DOMEQUE CAZCARRA, Juan	ARA
7.	GARCIA CORCHADO, Roger	CAT
8.	FRANCES LOPEZ, Enrique	NAV

### Trostrunde / Repechage / Ronda de consolación

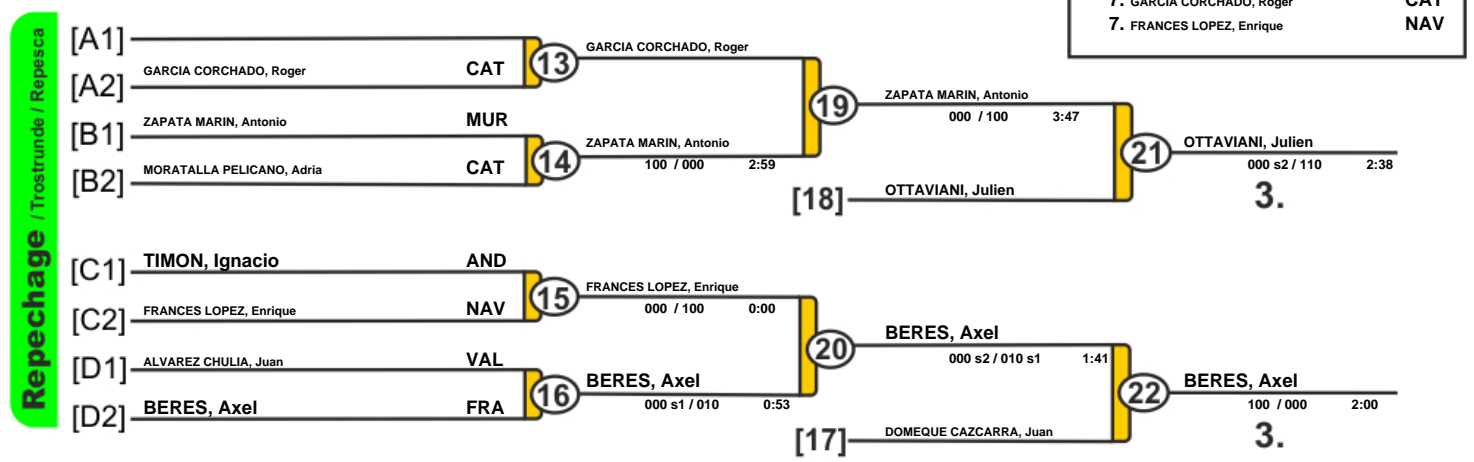



# Super Copa Espana Senior Barcelona 2019

Barcelona (CAT), 16 Feb 2019

**-73 kg**  
24 Judoka

**POOL A**

1	MASANES SEGARRA, Edgar	CAT	1	MASANES SEGARRA, Edgar
33			33	MASANES SEGARRA, Edgar 100 / 000 4:00
17			2	
49			49	MASANES SEGARRA, Edgar 100 / 000 4:00
9			3	
41			34	100 / 000 4:00
25			4	
57			57	MASANES SEGARRA, Edgar 100 / 000 s3 4:41
5	MAHE, Quentin	FRA	5	MAHE, Quentin
37			35	MAHE, Quentin 100 / 010 2:22
21	SARKISIANI, Tamazi	CAT	6	MARIN CARRILLO, Alex 000 / 110 s1 2:37
53	MARIN CARRILLO, Alex	VAL	6	
13	GASTOU, Julien	FRA	7	GASTOU, Julien 100 / 000 s1 3:21
45	REIG, Marc	AND	7	
29	CERCOS TUSET, Jordi	CAT	8	CERCOS TUSET, Jordi 110 / 000 1:04
61			8	

**POOL B**

3	FERNANDEZ PEREZ, Alvaro Jose	CAN	9	FERNANDEZ PEREZ, Alvaro Jose
35			37	FERNANDEZ PEREZ, Alvaro Jose 100 / 000 4:00
19			10	
51			51	FERNANDEZ PEREZ, Alvaro Jose 100 / 000 4:00
11			11	
43			38	100 / 000 4:00
27			12	
59			59	BLANCO BRAVO, Iker 000 s1 / 110 3:05
7	DESCAT, Peio	FRA	13	DESCAT, Peio 100 / 000 2:26
39	CRUZ LEONARTE, Leonardo	VAL	13	
23	ALUJAS BOTELLA, Xavier	CAT	14	ALUJAS BOTELLA, Xavier 100 / 000 4:00
55			14	
15	BLANCO BRAVO, Iker	CAT	15	BLANCO BRAVO, Iker 100 / 000 1:33
47			15	
31	AGUIRREZABAL COLLANTES, Jon	NAV	16	AGUIRREZABAL COLLANTES, Jon 100 / 000 0:35
63			16	

**POOL C**

2	BULDAIN ELIZALDE, Iban	ARA	17	BULDAIN ELIZALDE, Iban
34			41	BULDAIN ELIZALDE, Iban 100 / 000 4:00
18			18	
50			53	BULDAIN ELIZALDE, Iban 100 / 000 4:00
10			19	
42			42	100 / 000 4:00
26			20	
58			59	STEFFANUTTO, Lucas 000 / 100 1:06
6	STEFFANUTTO, Lucas	FRA	21	STEFFANUTTO, Lucas 110 / 000 1:20
38	CAMPILLO DE LA MAZA, Jordi	CAT	21	
22			43	STEFFANUTTO, Lucas 100 / 000 4:00
54			22	
14	RAMOS, Fabian	AND	23	RAMOS, Fabian 100 / 000 1:20
46			23	
30	INTXAURRONGO GONZALEZ, Aimar	CAT	24	INTXAURRONGO GONZALEZ, Aimar 100 / 000 1:26
62			24	

**POOL D**

4	BENDELIANI, Giorgi	CAT	25	BENDELIANI, Giorgi
36			45	BENDELIANI, Giorgi 100 / 000 4:00
20			26	
52			55	BENDELIANI, Giorgi 100 / 000 4:00
12			27	
44			46	100 / 000 4:00
28			28	
60			60	BENDELIANI, Giorgi 110 / 000 1:29
8	ROSSELL, Joel	AND	29	ROSSELL, Joel 100 / 000 1:45
40			47	ROSSELL, Joel
24	LEIVA SIERRA, Cristobal	CAT	30	LEIVA SIERRA, Cristobal 100 / 000 0:00
56			31	SANZ TORROME, Miguel
16	SANZ TORROME, Miguel	VAL	31	
48			48	CROMBEZ, Thibault 010 / 100 1:47
32	CROMBEZ, Thibault	FRA	32	CROMBEZ, Thibault 100 / 000 0:00
64	SINTES PONS, Marc	CAT	32	

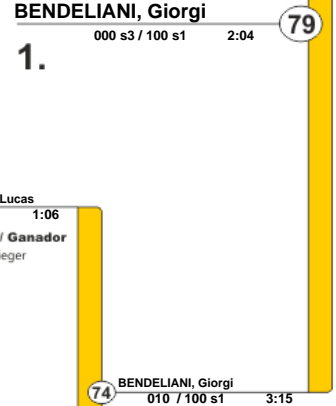

**Results**  
Résultat / Platzierungen / Resultados

1.	BENDELIANI, Giorgi	CAT
2.	MASANES SEGARRA, Edgar	CAT
3.	STEFFANUTTO, Lucas	FRA
3.	BULDAIN ELIZALDE, Iban	ARA
5.	FERNANDEZ PEREZ, Alvaro Jose	CAN
5.	BLANCO BRAVO, Iker	CAT
7.	GASTOU, Julien	FRA
7.	CROMBEZ, Thibault	FRA

**Trostrunde / Repechage / Ronda de consolación**

**Repechage / Trostrunde / Repechage**

[A1]				
[A2]			61	
[B1]			65	100 / 000 4:00
[B2]	AGUIRREZABAL COLLANTES, Jon	NAV	62	AGUIRREZABAL COLLANTES, Jon
[C1]	CAMPILLO DE LA MAZA, Jordi	CAT	63	CAMPILLO DE LA MAZA, Jordi 100 / 000 4:00
[C2]			67	CAMPILLO DE LA MAZA, Jordi 010 / 000 2:47
[D1]			71	BULDAIN ELIZALDE, Iban 000 / 100 2:40
[D2]			64	
[D3]			68	100 / 000 4:00
[D4]			72	CROMBEZ, Thibault 000 / 100 4:00
[A3]			69	GASTOU, Julien 000 / 100 4:00
[A4]			75	FERNANDEZ PEREZ, Alvaro Jose 000 / 100 3:07
[B3]	DESCAT, Peio		66	AGUIRREZABAL COLLANTES, Jon 100 / 000 0:00
[B4]			70	FERNANDEZ PEREZ, Alvaro Jose 000 / 100 s1 2:15
[C3]			74	STEFFANUTTO, Lucas 000 / 110 2:59
[C4]			76	BULDAIN ELIZALDE, Iban 010 / 000 s2 3:14
[D3]			73	BLANCO BRAVO, Iker
[D4]			78	BULDAIN ELIZALDE, Iban 010 s1 / 000 s1 4:00





# Super Copa Espana Senior Barcelona 2019

Barcelona (CAT), 16 Feb 2019

# -81 kg

26 Judoka

POOL A

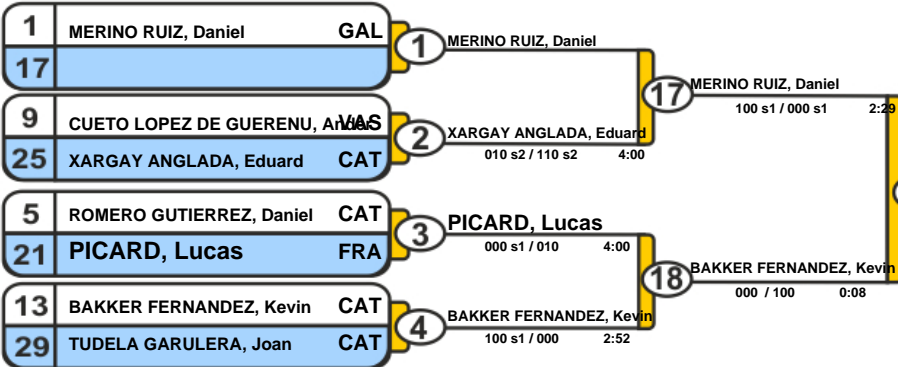

POOL B

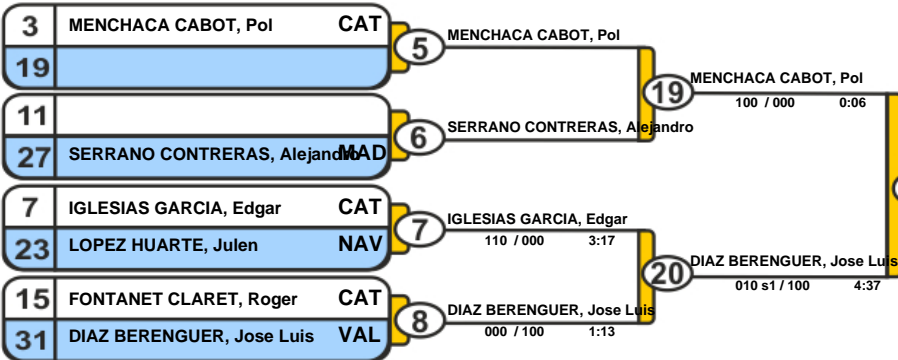

POOL C

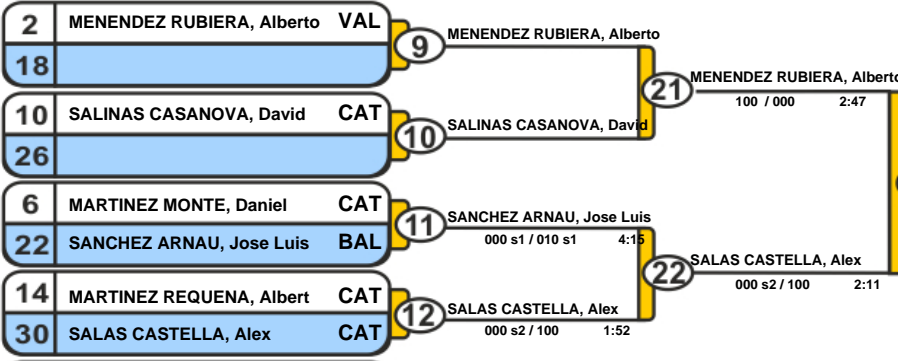

POOL D

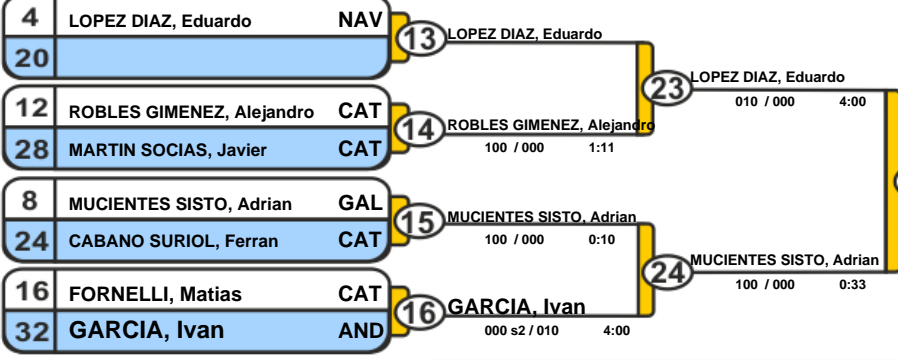

MENEDEZ RUBIERA, Alberto

1. 010 s3 / 100 s1 3:52

43

Results	
Résultat / Platzierungen / Resultados	
1.	MENEDEZ RUBIERA, Alberto VAL
2.	BAKKER FERNANDEZ, Kevin CAT
3.	MERINO RUIZ, Daniel GAL
3.	MENCHACA CABOT, Pol CAT
5.	MUCIENTES SISTO, Adrian GAL
5.	LOPEZ DIAZ, Eduardo NAV
7.	DIAZ BERENGUER, Jose Luis VAL
7.	SALAS CASTELLA, Alex CAT

## Trostrunde / Repechage / Ronda de consolación

Repechage / Trostrunde / Repechage

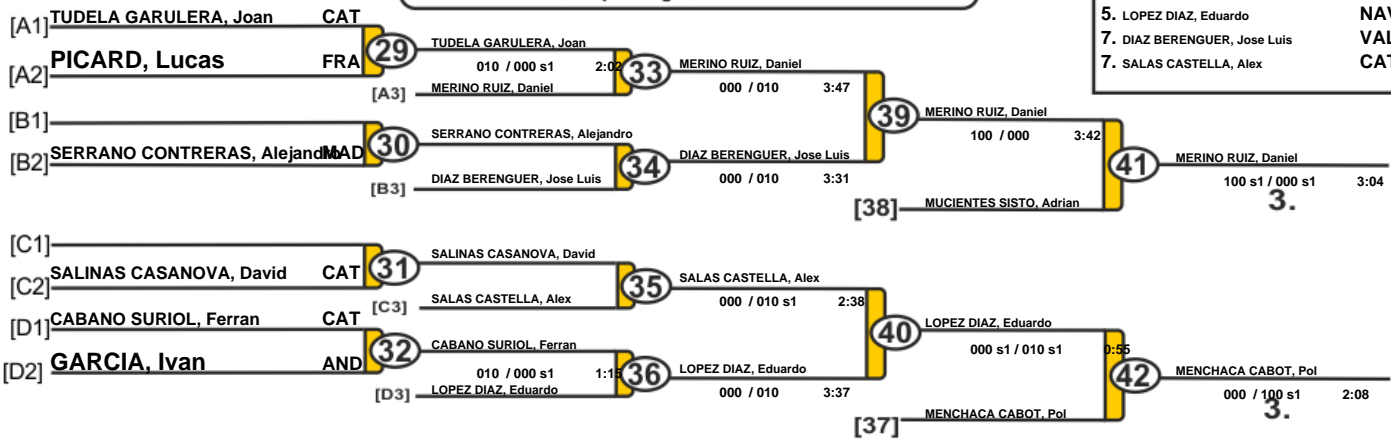





# Super Copa Espana Senior Barcelona 2019

Barcelona (CAT), 16 Feb 2019

## -90 kg

11 Judoka

POOL A

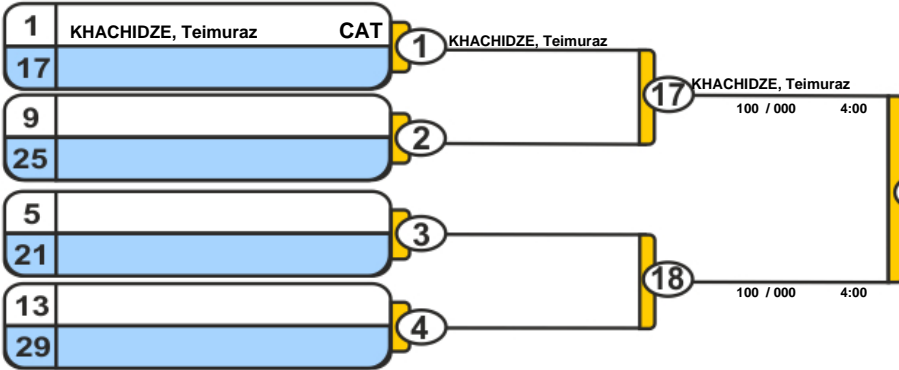

POOL B

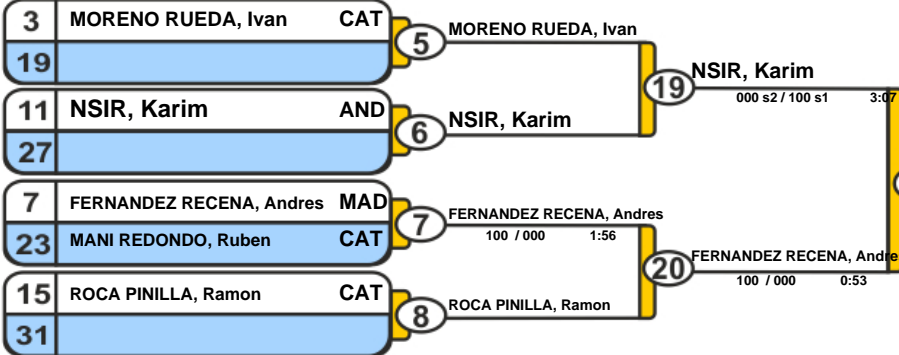

POOL C

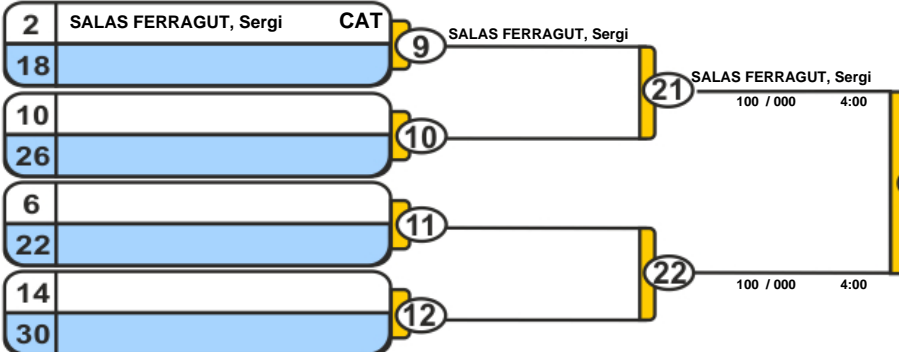

POOL D

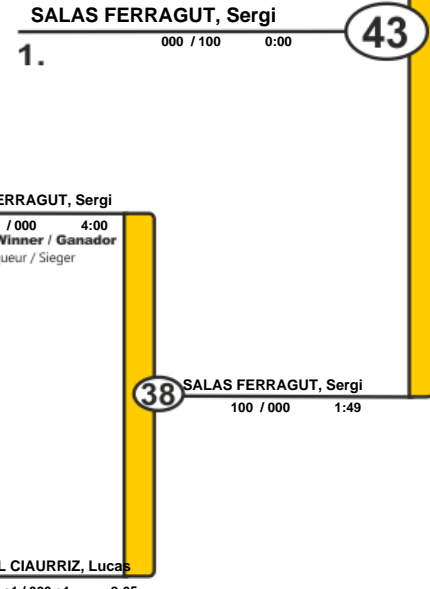
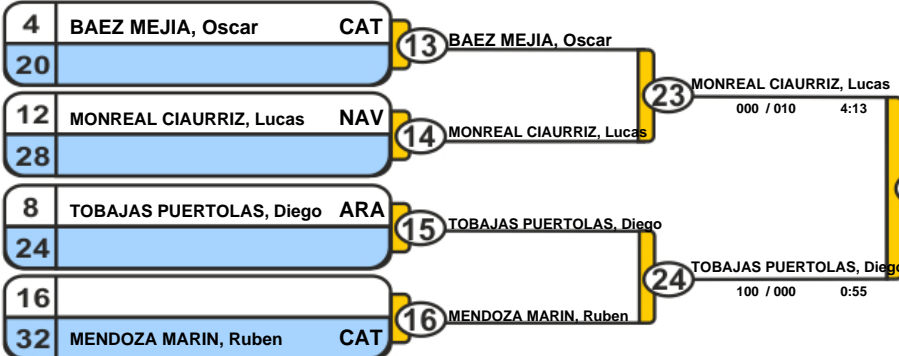

Results	
Résultat / Platzierungen / Resultados	
1.	SALAS FERRAGUT, Sergi CAT
2.	KHACHIDZE, Teimuraz CAT
3.	MANI REDONDO, Ruben CAT
5.	FERNANDEZ RECENA, Andres MAD
5.	MONREAL CIAURRIZ, Lucas NAV
5.	BAEZ MEJIA, Oscar CAT
7.	
7.	

### Trostrunde / Repechage / Ronda de consolación

Repechage / Trostrunde / Repechage

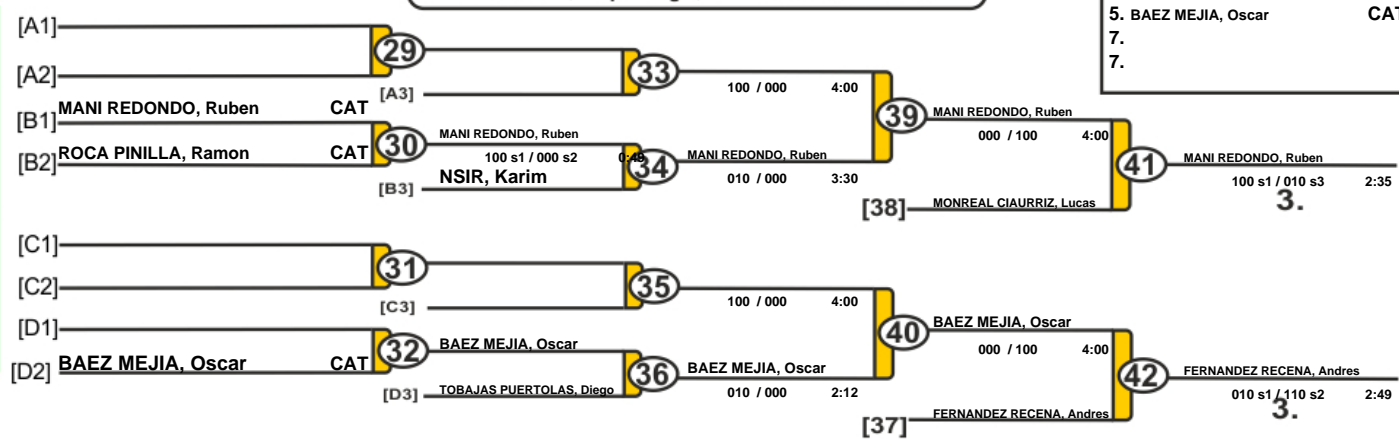



# Super Copa Espana Senior Barcelona 2019

Barcelona (CAT), 16 Feb 2019

## -100 kg

8 Judoka

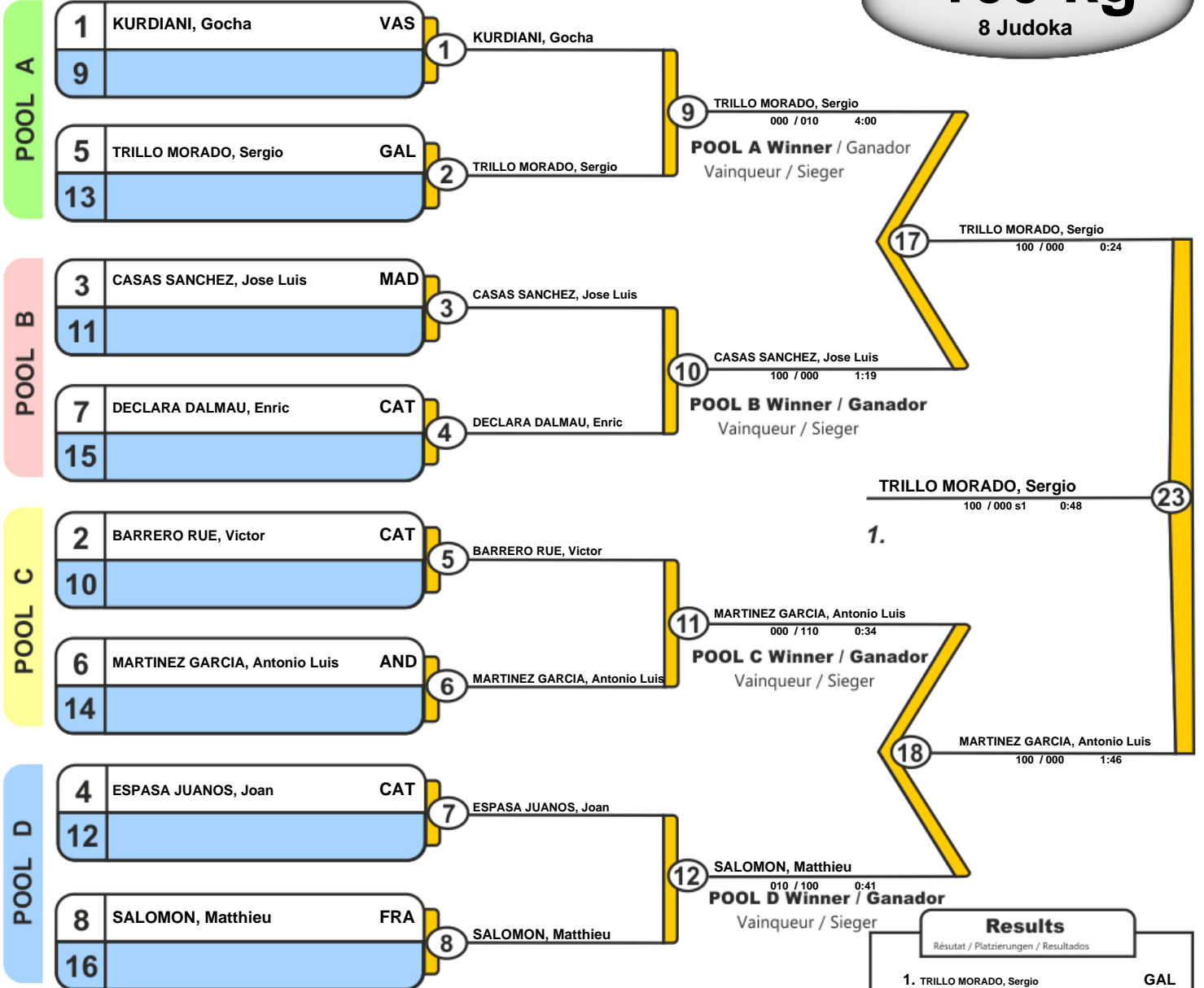

Results		
Résultat / Platzierungen / Resultados		
1.	TRILLO MORADO, Sergio	GAL
2.	MARTINEZ GARCIA, Antonio Luis	AND
3.	KURDIANI, Gocha	VAS
3.	BARRERO RUE, Victor	CAT
5.	SALOMON, Matthieu	FRA
7.	CASAS SANCHEZ, Jose Luis	MAD
7.	DECLARA DALMAU, Enric	CAT
7.	ESPASA JUANOS, Joan	CAT

### Trostrunde / Repechage / Ronda de consolación

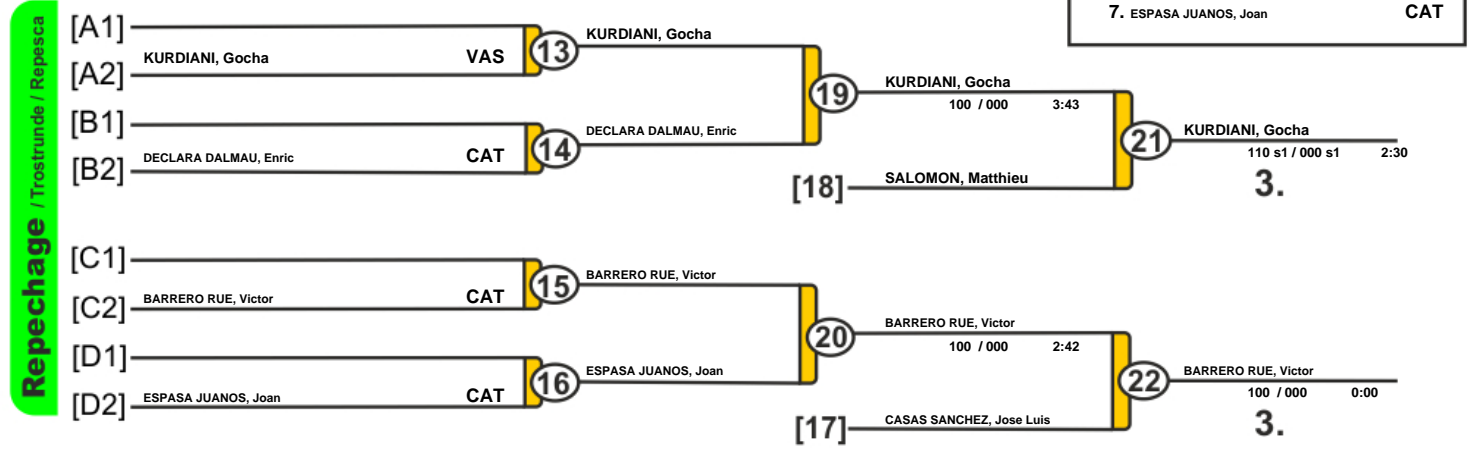



# Super Copa Espana Senior Barcelona 2019

Barcelona (CAT), 16 Feb 2019

## +100 kg

6 Judoka

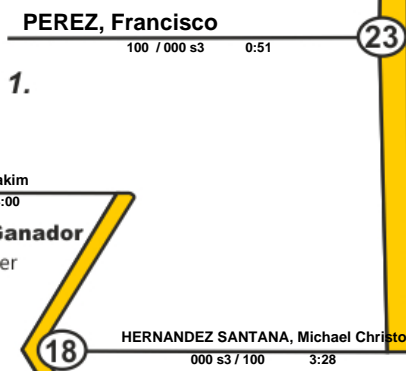
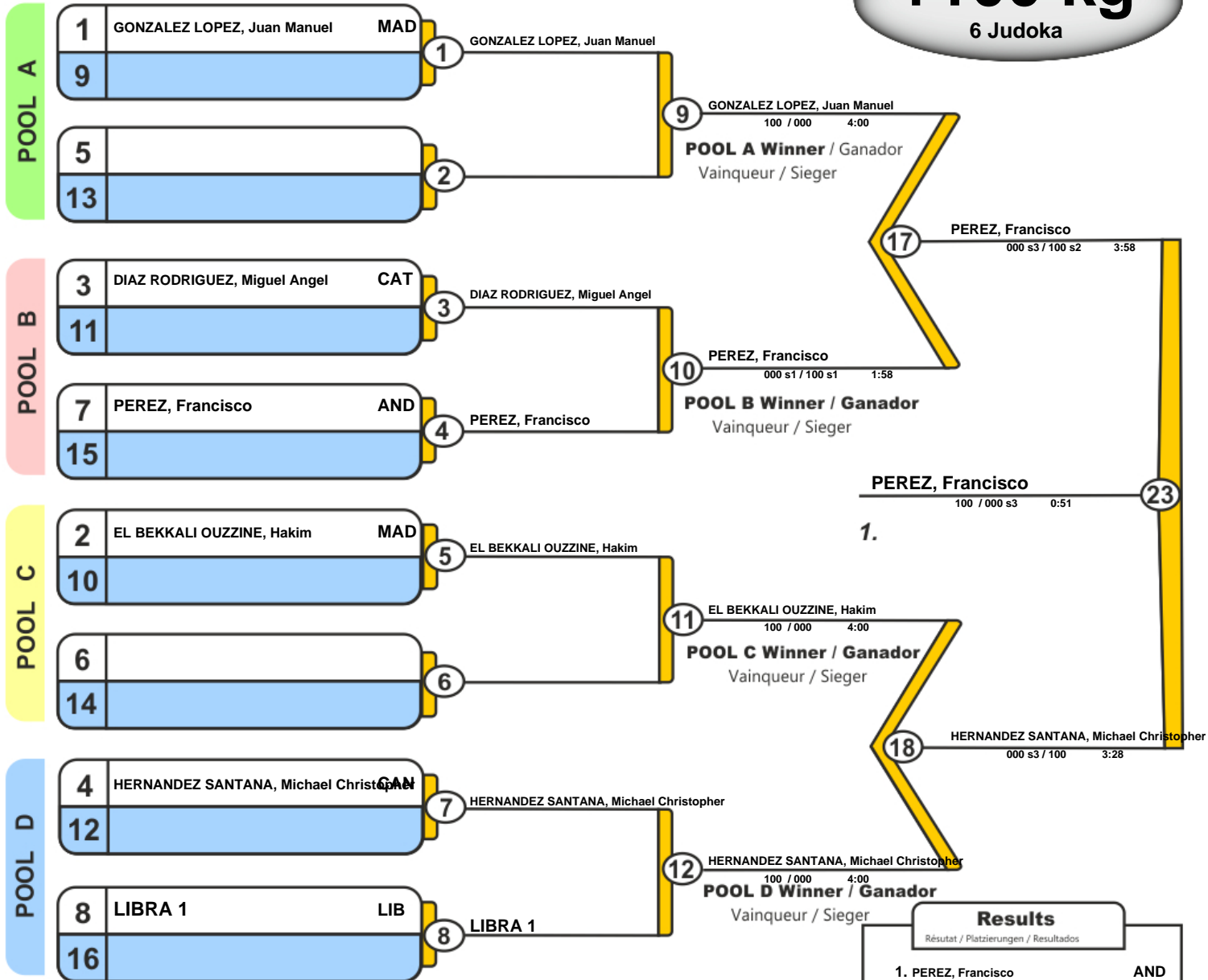

Results		
Rèultat / Platzierungen / Resultados		
1.	PEREZ, Francisco	AND
2.	HERNANDEZ SANTANA, Michael Christopher	CAN
3.	DIAZ RODRIGUEZ, Miguel Angel	CAT
3.	GONZALEZ LOPEZ, Juan Manuel	MAD
5.	EL BEKKALI OUZZINE, Hakim	MAD
5.	LIBRA 1	LIB
7.		
7.		

Trostrunde / Repechage / Ronda de consolación

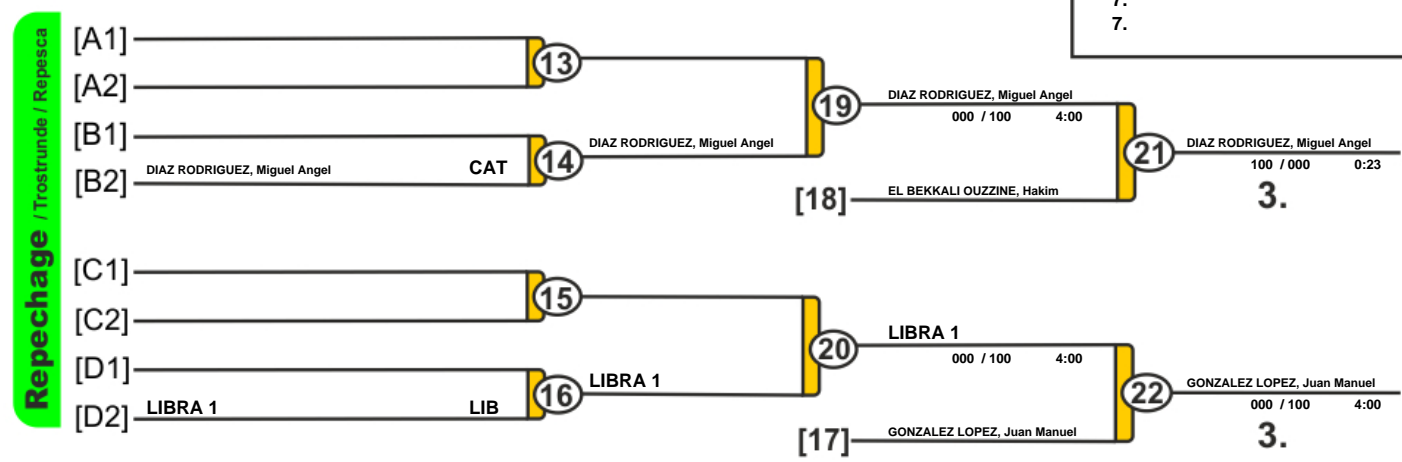



# Super Copa Espana Senior Barcelona 2019

Barcelona (CAT), 16 Feb 2019

## -48 kg

6 Judoka

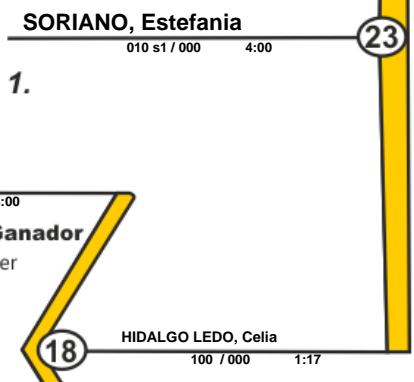
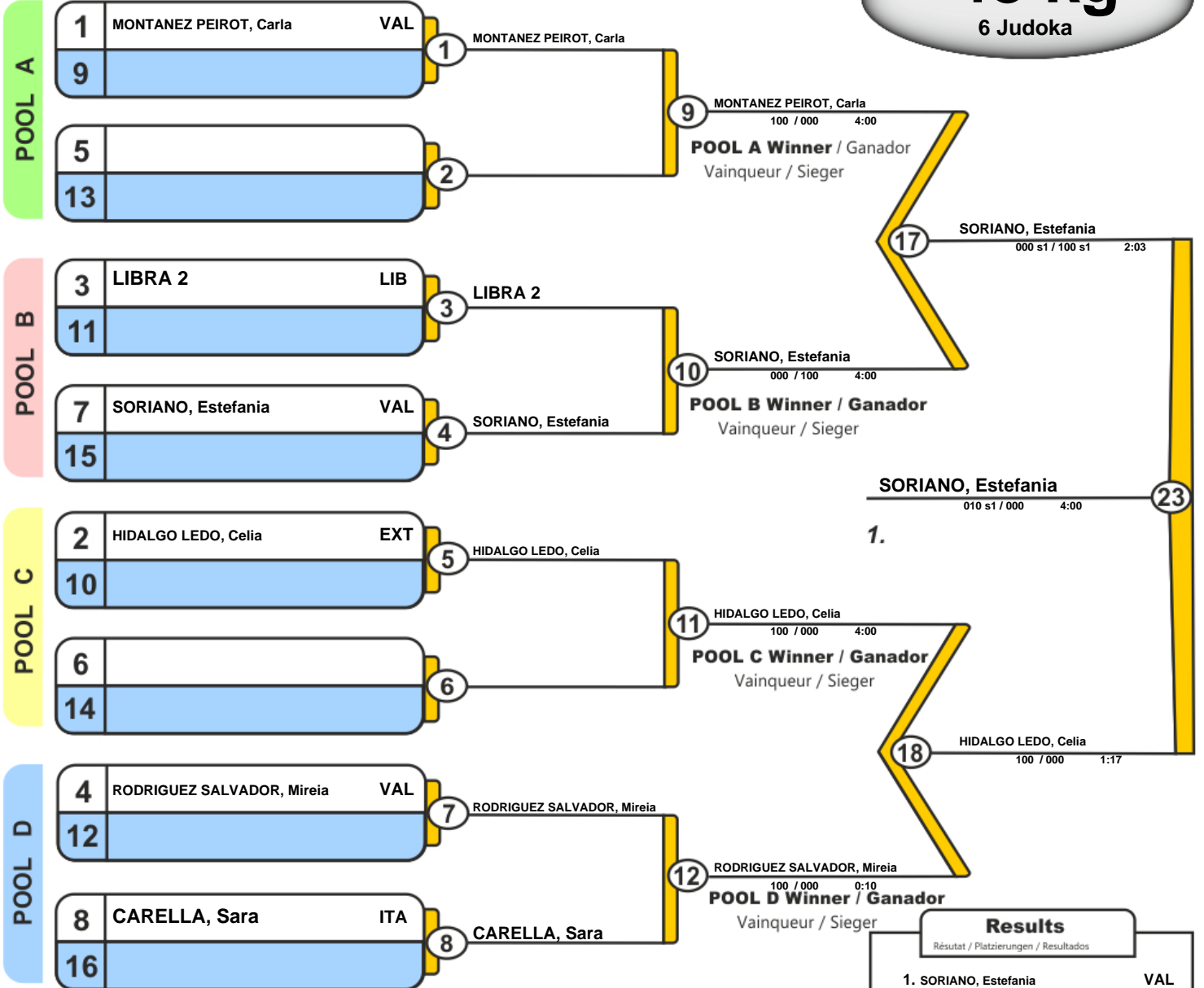

Results		
Rèultat / Platzierungen / Resultados		
1.	SORIANO, Estefania	VAL
2.	HIDALGO LEDO, Celia	EXT
3.	RODRIGUEZ SALVADOR, Mireia	VAL
3.	MONTANEZ PEIROT, Carla	VAL
5.	LIBRA 2	LIB
5.	CARELLA, Sara	ITA
7.		
7.		

Trostrunde / Repechage / Ronda de consolación

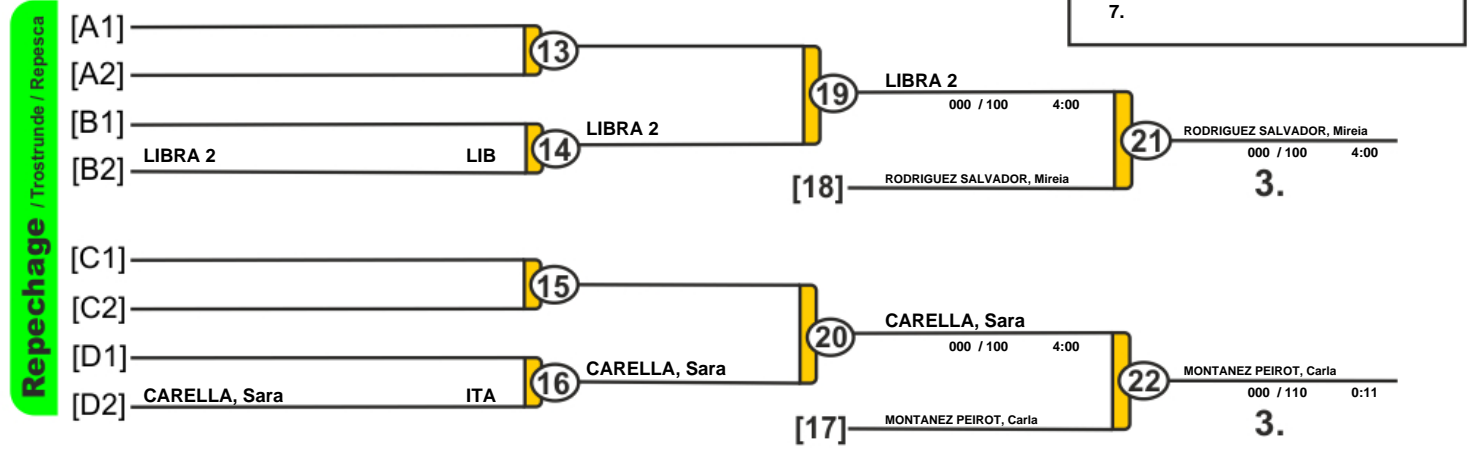





# Super Copa Espana Senior Barcelona 2019

Barcelona (CAT), 16 Feb 2019

## -52 kg

9 Judoka

POOL A

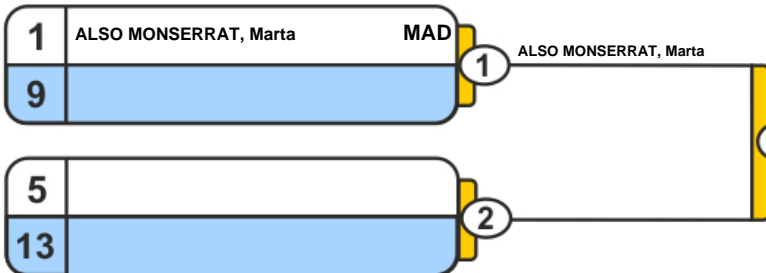

POOL B

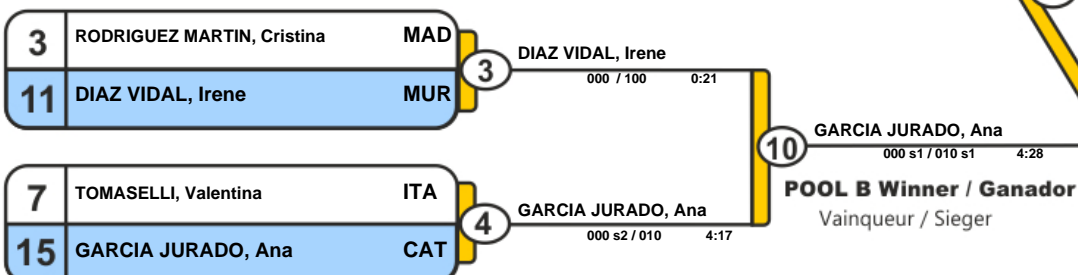

POOL C

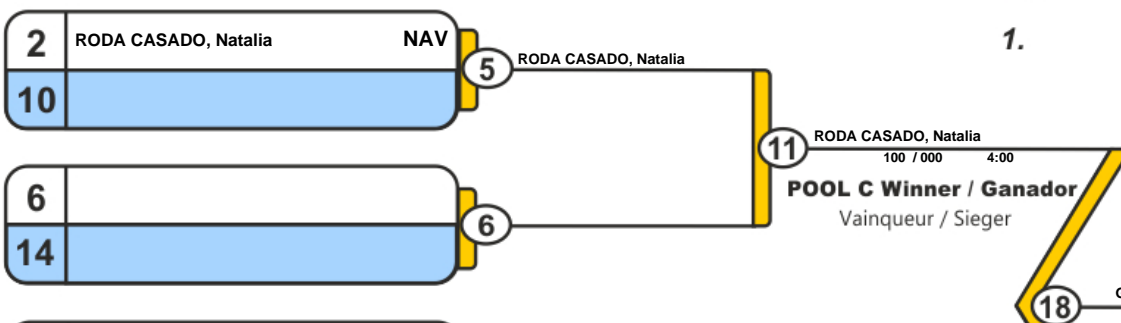

POOL D

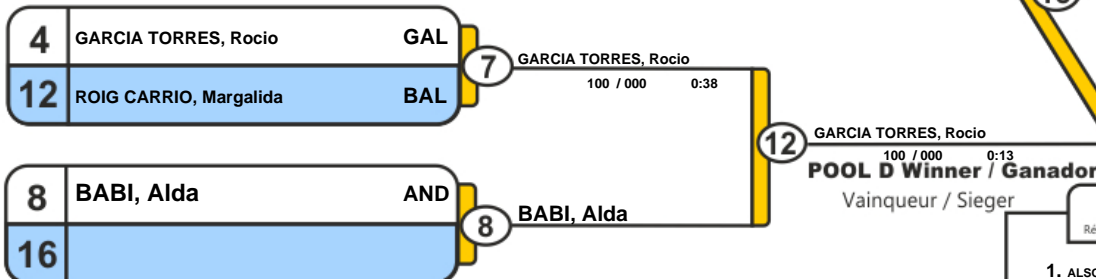

Results	
Rèstat / Platzierungen / Resultados	
1.	ALSO MONSERRAT, Marta
2.	GARCIA TORRES, Rocio
3.	DIAZ VIDAL, Irene
3.	GARCIA JURADO, Ana
5.	RODA CASADO, Natalia
5.	ROIG CARRIO, Margalida
7.	
7.	

### Trostrunde / Repechage / Ronda de consolación

Repechage / Trostrunde / Repesca

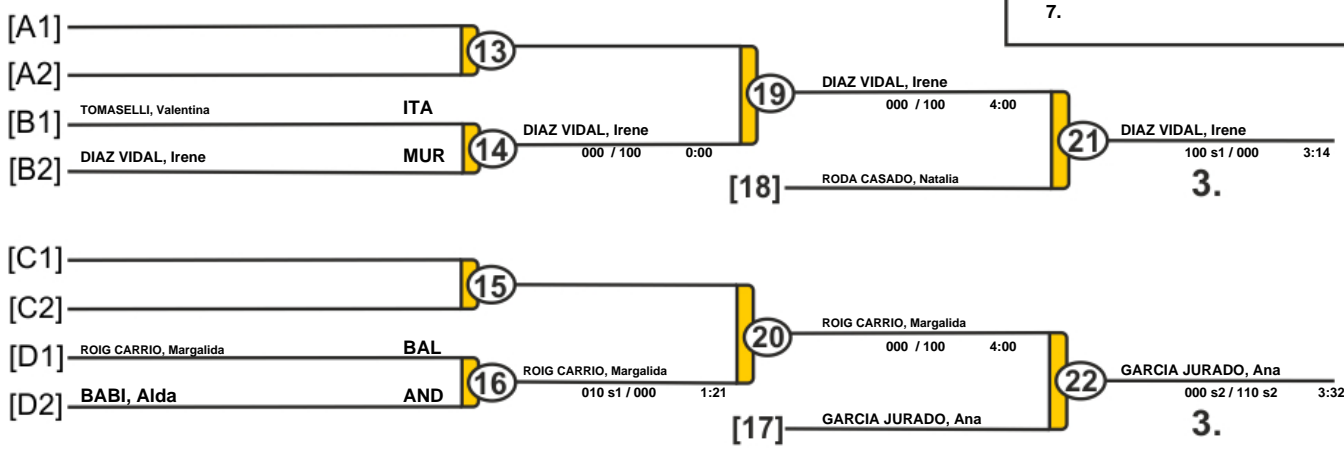



# Super Copa Espana Senior Barcelona 2019

Barcelona (CAT), 16 Feb 2019

## -57 kg

13 Judoka

POOL A

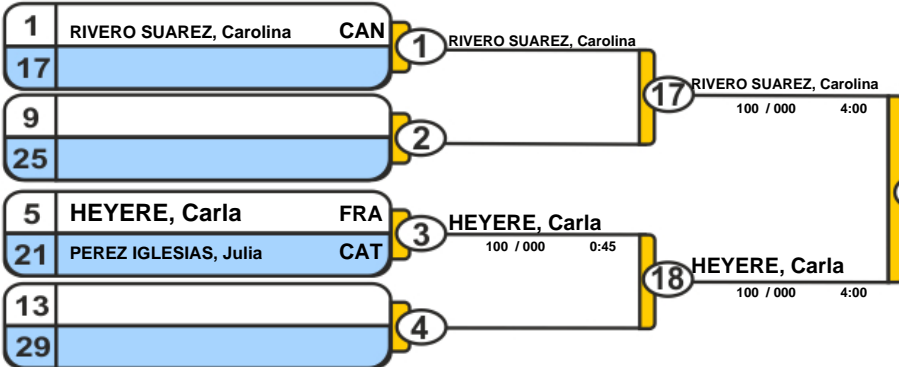

POOL B

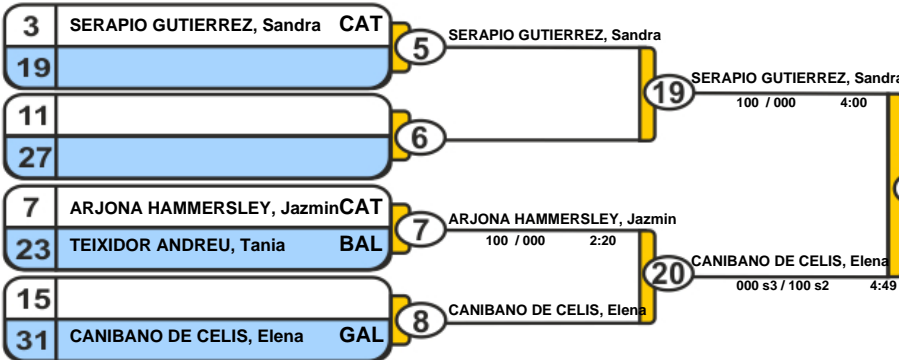

POOL C

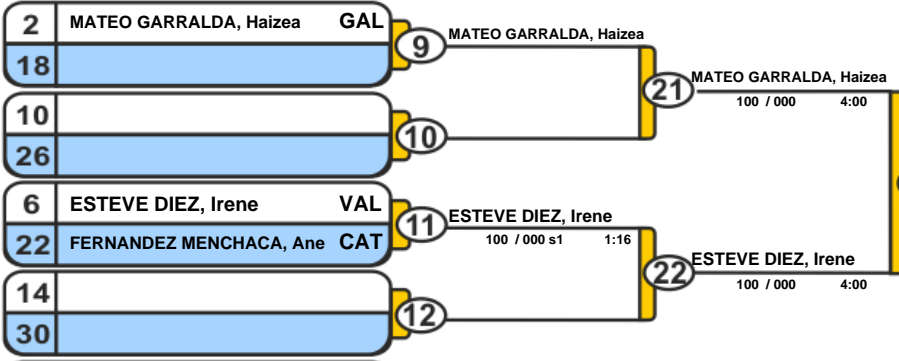

POOL D

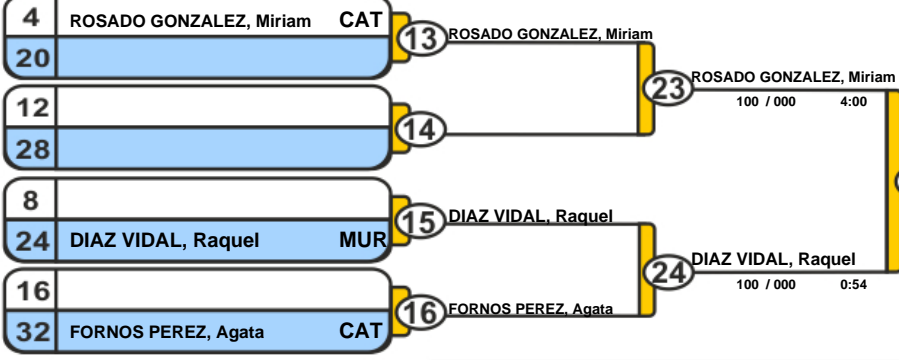

DIAZ VIDAL, Raquel  
1. 000 s2 / 010 s2 4:00 43

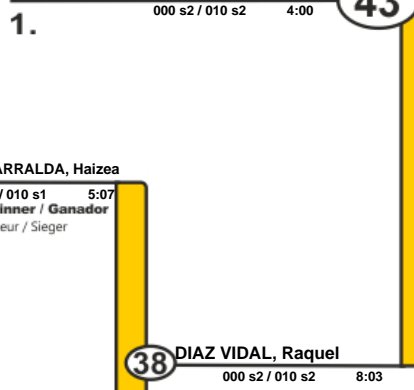

Results	
Résultat / Platzierungen / Resultados	
1.	DIAZ VIDAL, Raquel MUR
2.	CANIBANO DE CELIS, Elena GAL
3.	MATEO GARRALDA, Haizea GAL
4.	RIVERO SUAREZ, Carolina CAN
5.	HEYERE, Carla FRA
6.	ESTEVE DIEZ, Irene VAL
7.	SERAPIO GUTIERREZ, Sandra CAT
8.	ROSADO GONZALEZ, Miriam CAT

### Trostrunde / Repechage / Ronda de consolación

Repechage / Trostrunde / Repechage

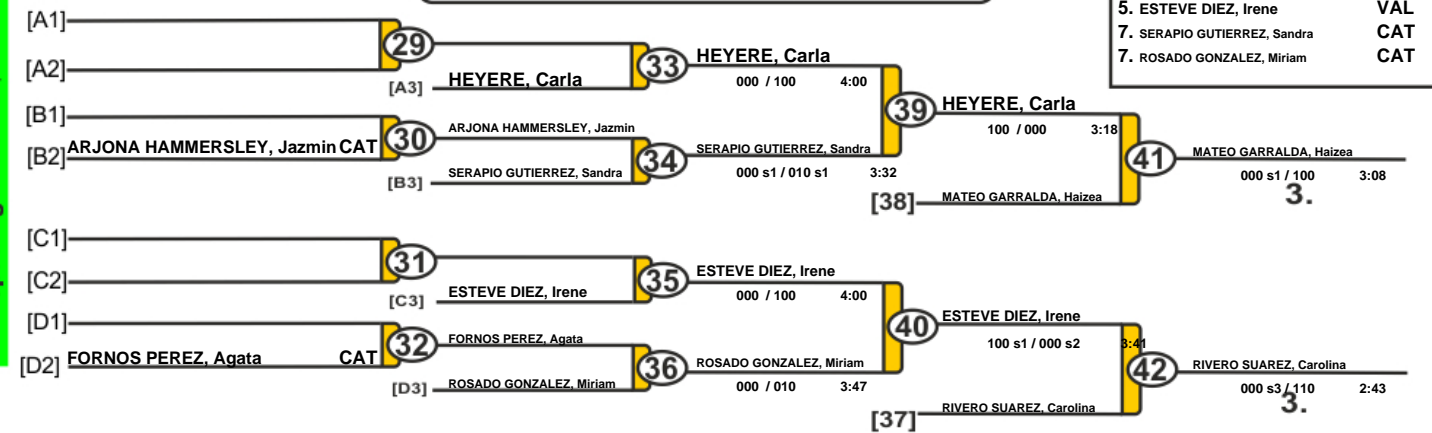



# Super Copa Espana Senior Barcelona 2019

Barcelona (CAT), 16 Feb 2019

## -63 kg

9 Judoka

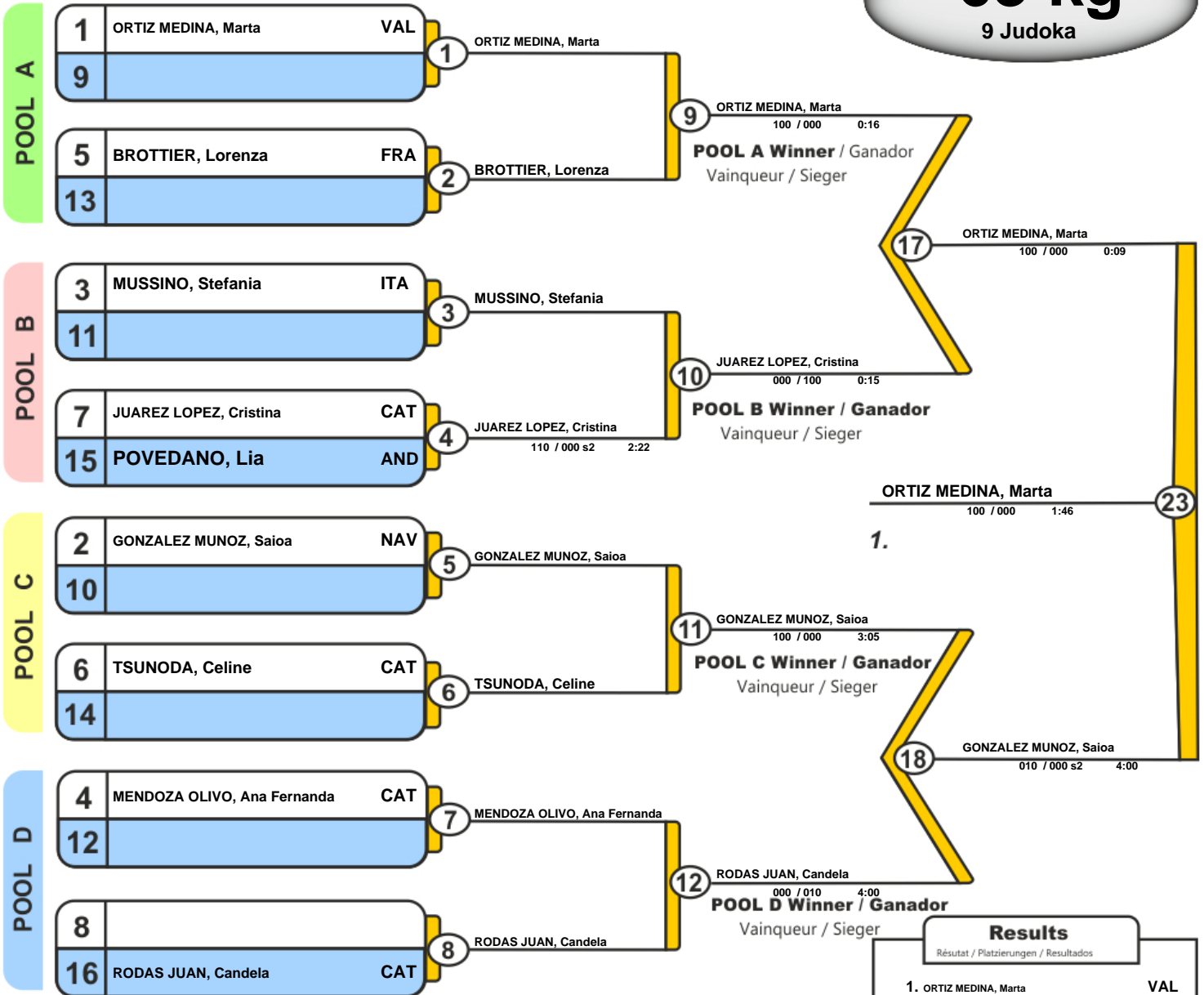

Results		
Résultat / Platzierungen / Resultados		
1.	ORTIZ MEDINA, Marta	VAL
2.	GONZALEZ MUNOZ, Saioa	NAV
3.	BROTTIER, Lorenza	FRA
3.	TSUNODA, Celine	CAT
5.	RODAS JUAN, Candela	CAT
5.	JUAREZ LOPEZ, Cristina	CAT
7.	MUSSINO, Stefania	ITA
7.	MENDOZA OLIVO, Ana Fernanda	CAT

### Trostrunde / Repechage / Ronda de consolación

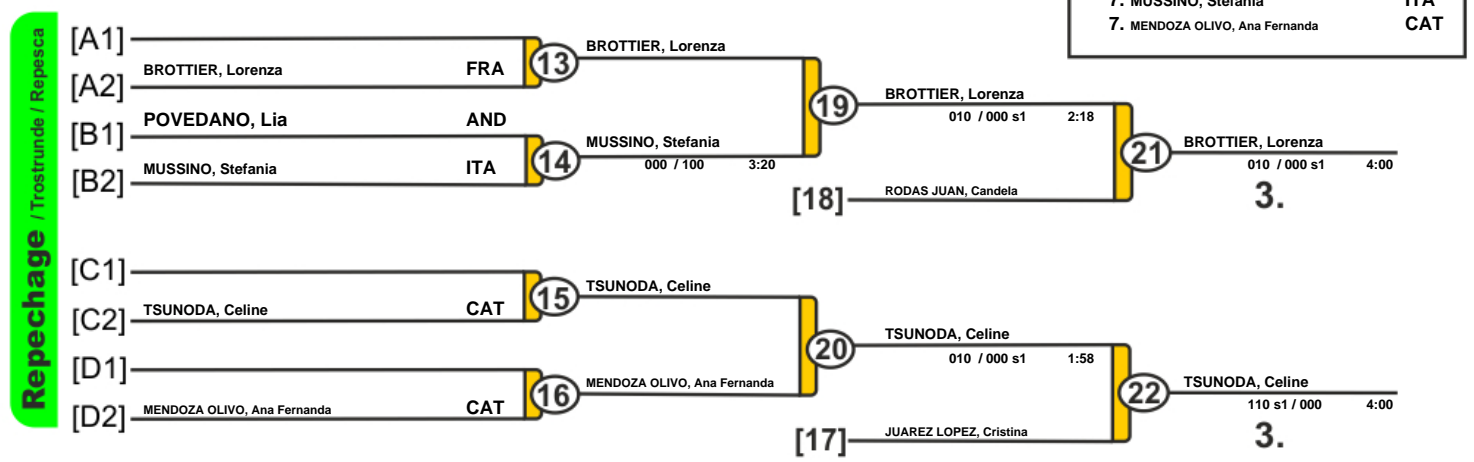

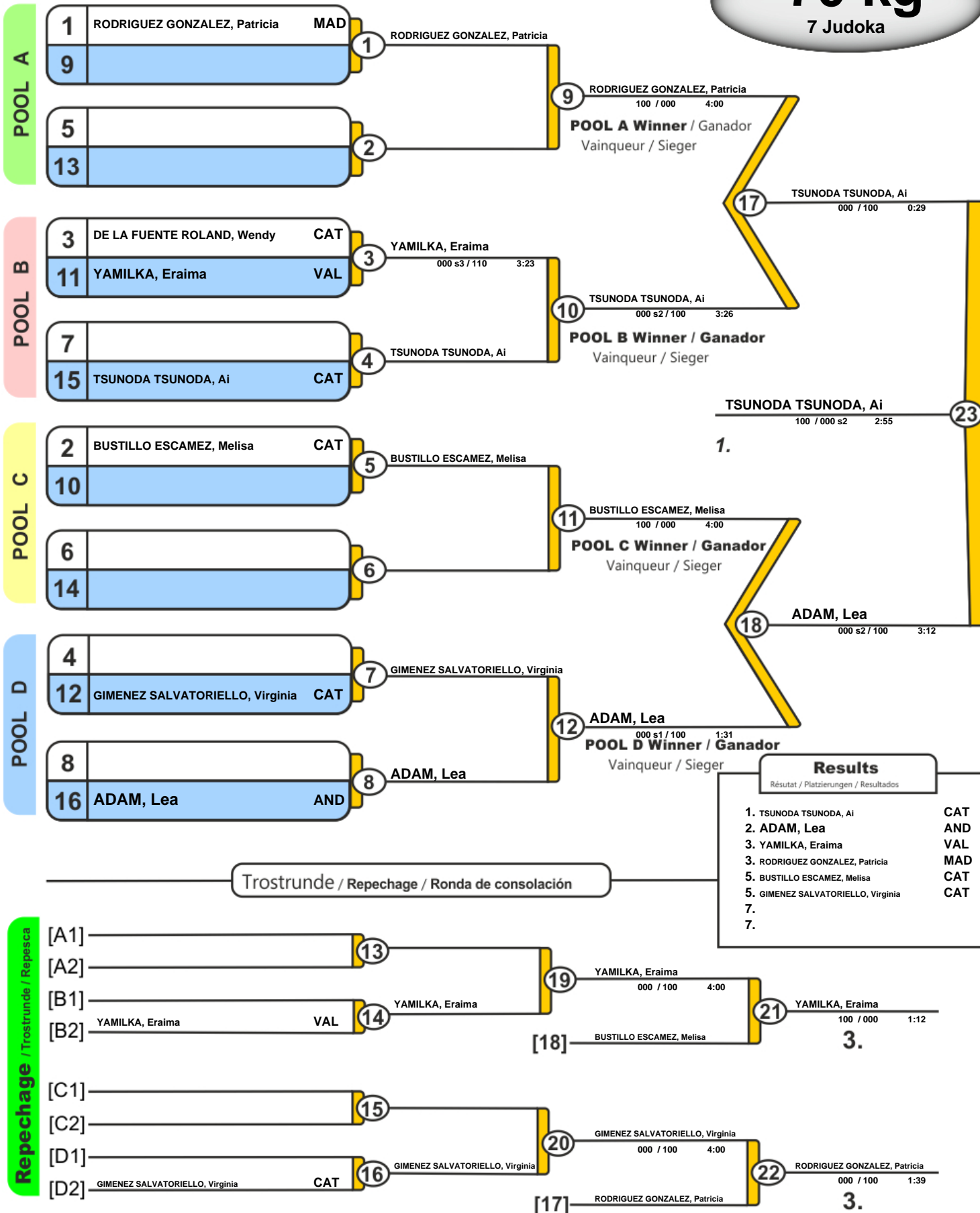



			1	2	3	4	
1	GARCIA AGUILAR, Silvia	MAD		1 (10)	1 (10)	1 (10)	3 (30)
2	PIERRON, Charlene	FRA	0		0	1 (10)	1 (10)
3	YARZA OLASO, Lidia	VAL	0	1 (10)		1 (10)	2 (20)
4	ABRESCIA, Sabrina	ITA	0	0	0		0 (0)

1	GARCIA AGUILAR, Silvia	MAD	①	<b>GARCIA AGUILAR, Silvia MAD</b>
2	PIERRON, Charlene	FRA		10 / 00 s2      4:00

3	YARZA OLASO, Lidia	VAL	②	<b>YARZA OLASO, Lidia VAL</b>
4	ABRESCIA, Sabrina	ITA		10 / 00      0:20

1	GARCIA AGUILAR, Silvia	MAD	③	<b>GARCIA AGUILAR, Silvia MAD</b>
3	YARZA OLASO, Lidia	VAL		11 s1 / 01      3:58

2	PIERRON, Charlene	FRA	④	<b>PIERRON, Charlene FRA</b>
4	ABRESCIA, Sabrina	ITA		10 / 00 s1      0:57

1	GARCIA AGUILAR, Silvia	MAD	⑤	<b>GARCIA AGUILAR, Silvia MAD</b>
4	ABRESCIA, Sabrina	ITA		10 / 00      0:44

2	PIERRON, Charlene	FRA	⑥	<b>YARZA OLASO, Lidia VAL</b>
3	YARZA OLASO, Lidia	VAL		00 s1 / 10 s1      0:53



## Final Results

1.	GARCIA AGUILAR, Silvia	MAD
2.	YARZA OLASO, Lidia	VAL
3.	PIERRON, Charlene	FRA



# Super Copa Espana Senior Barcelona 2019

Barcelona (CAT), 16 Feb 2019

# +78 kg

2 Judoka

## Best of Three

1	ANTON ELIAS, Marta	CAT	1	ANTON ELIAS, Marta	CAT
2	ELIZALDE BRIGANTE, Belen	VAL		10 / 00 s1	1:59

1	ANTON ELIAS, Marta	CAT	2	ANTON ELIAS, Marta	CAT
2	ELIZALDE BRIGANTE, Belen	VAL		10 s1 / 00	1:51

1	ANTON ELIAS, Marta	CAT	3	ANTON ELIAS, Marta	CAT
2	ELIZALDE BRIGANTE, Belen	VAL		10 / 00	0:54



### Final Results

1. ANTON ELIAS, Marta CAT
2. ELIZALDE BRIGANTE, Belen VAL